

EBINGER

Technisches Equipment

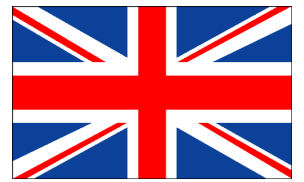

Hose reels

Hose reels and manual hose carts for water



Hose reel R3



- Latching system
- Extension spring „Made in Germany“ 
- Adjustable spring tension
- Special smooth-running swivel joint
- Wall bracket 180° swivelling made of galvanised steel
- Casing made of polypropylene - UV-resistant and shockproof
- Frost-proof

5 years warranty
10 years spare parts availability

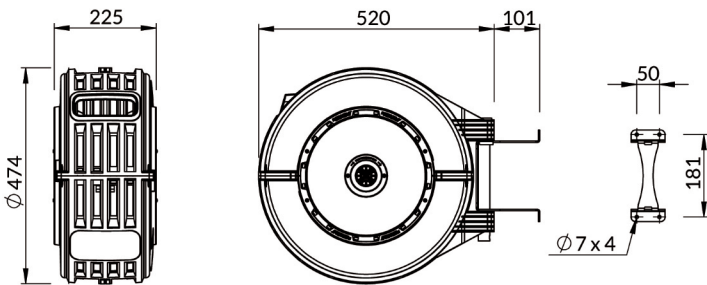

Medium	Model	hose	Ø	Max. pressure	Max. temp.	swivel (PVC)	Swivel connection	Armature/ Lieferumfang	Item-No.
Cold water	DR 100-R3*	25m PVC-hose	1/2"	8bar	50°C	3/4" M	GD system	brass	1.100.101
	DR 200-R3*	20m PVC-hose	5/8"	8bar	50°C	3/4" M	brass coupling	brass	1.100.102
	DR 300-R3*	10m PVC-hose	3/4"	8bar	50°C	3/4" M	brass coupling	brass	1.100.103

*Incl. 2m connection hose & brass spray gun

Optional accessories

Designation	Material	Item-No.
Floor bracket (heavy-duty version, e. g. for mounting on vehicles, fig. 1)	galv. steel	1.100.001
Fixation of floor bracket, heavy-duty version (fig. 2)	galv. steel	1.100.003
Floor bracket (light version, fig. 3)	galv. steel	1.100.004

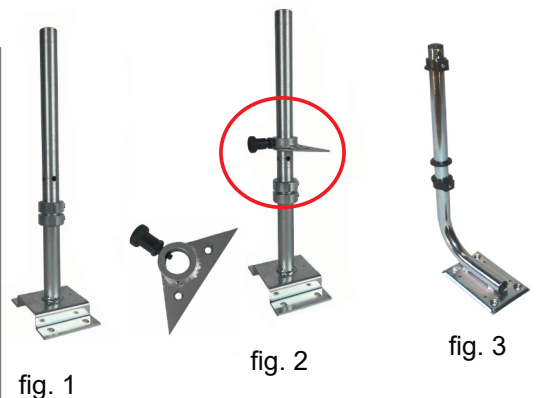

Spring rewind mechanism & latching system
Tension spring „Made in Germany“ 

Available in various materials:



OSM series with metal casing



Painted steel
RAL 7016

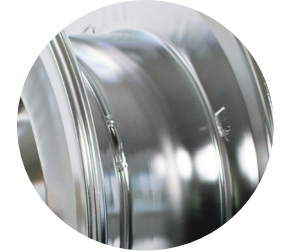

Stainless steel

OSK series with ABS plastic casing in RAL 7016**

► 20% weight reduction



Mounting bracket and axle in
Painted steel
RAL 7016**



Stainless steel

High quality swivel joint

Fixed* or swivel mounting bracket

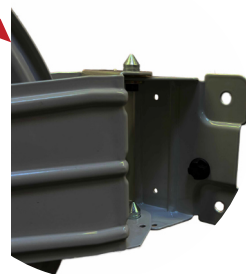

Adjustable hose guide

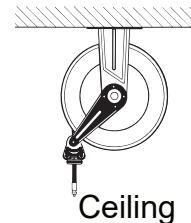

Ceiling

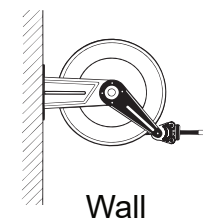

Wall

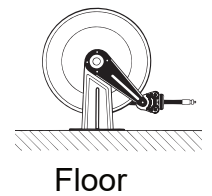

Floor

Hose reel OSM / OSK,
Fixed mounting bracket*

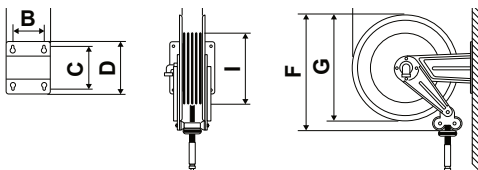

Hose reel OSM / OSK,
Swivel mounting bracket

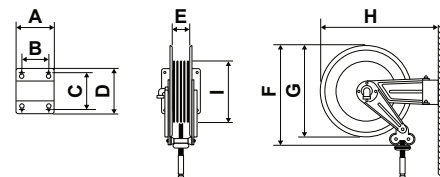

Model	A	B	C	D	E	F	G	H	I	kg
OSM 210	186	140	196	226	98	390	350	365	155	8,1
OSM 400	186	140	197	226	97	450	415	456	264	14,0
OSM 500	203	153	221	258	104	535	510	558	315	17,5
OSM 610	300	218	227	268	165	535	510	572	315	23,5
OSM 710	488	399	238	272	348	535	510	578	315	42,5
OSK 400	186	140	197	226	110	450	425	461	259	12,5
OSK 500	203	153	221	258	121	535	510	558	327	15,0
OSK 610	300	218	227	268	190	535	510	700	327	19,5

*Optional retrofittable swivel wall bracket





**Conversion to RAL 7016 takes place gradually

Model	A	B	C	D	E	F	G	H	I	kg
OSM 310	184	146	106	144	98	410	390	482	155	9,5
OSM 410	208	162	118	164	97	450	415	540	264	13,0
OSM 510	228	182	154	200	104	535	510	642	315	17,5
OSM 400*	186	140	197	226	97	450	415	556	264	13,0
OSM 500*	203	153	221	258	104	535	510	658	315	17,5
OSM 610*	300	218	227	268	165	535	510	700	315	23,5
OSM 710*	488	399	238	272	348	535	510	768	315	42,5
OSK 400*	186	140	197	226	110	450	425	561	259	12,5
OSK 500*	203	153	221	258	121	535	510	658	327	15,0

Overview OSM / OSK 210 - 410

EBINGER

Technisches Equipment

Model	Material	Hose diameter Ø	Connection swivel joint*	Item-No.	Length
				PVC-hose Cold water up to 10bar / 50°C	
OSM 210 Fixed mountig bracket 	Painted steel	without hose	1/2" F	1.210.100	-
	Stainless steel			1.214.100	
	Painted steel	1/2" (12,5mm)		1.210.101	10m
	Stainless steel			1.214.101	
	Painted steel	5/8" (15,5mm)		1.210.108	7m
	Stainless steel			1.214.108	
OSM 310 Swivel wall bracket 	Painted steel	without hose	1/2" F	1.310.100	-
	Stainless steel			1.314.100	
	Painted steel	1/2" (12,5mm)		1.310.101	15m
	Stainless steel			1.314.101	
OSM 400 Fixed mountig bracket 	Painted steel	without hose	1/2" F	1.400.100	-
	Stainless steel			1.404.100	
	Painted steel	1/2" (12,5mm)		1.400.101	20m
	Stainless steel			1.404.101	
	Painted steel	5/8" (15,5mm)		1.400.102	15m
	Stainless steel			1.404.102	
OSK 400 Fixed mountig bracket 	Painted steel / ABS	without hose	1/2" F	3.400.100	-
	Stainless steel / ABS			3.404.100	
	Painted steel / ABS	1/2" (12,5mm)		3.400.101	20m
	Stainless steel / ABS			3.404.101	
	Painted steel / ABS	5/8" (15,5mm)		3.400.102	15m
	Stainless steel / ABS			3.404.102	
OSM 410 Swivel wall bracket 	Painted steel	without hose	1/2" F	1.410.100	-
	Stainless steel			1.414.100	
	Painted steel	1/2" (12,5mm)		1.410.101	20m
	Stainless steel			1.414.101	
	Painted steel	5/8" (15,5mm)		1.410.102	15m
	Stainless steel			1.414.102	

*All hose reels incl. hose are equipped with an brass coupling

Overview OSM / OSK 210 - 410

Item-No.	Length	Item-No.	Length	Item-No.	Length
rubber hose ET hot water up to 15bar / 90°C		Food hose, resistant to animal & vegetable fats up to 15bar / 100°C		TPE hose Drinking water KTW-A, TZW AZ: 5-0885/21, DIN EN 16421: 2015-05 up to 10bar / 60°C	
					
1.210.100	-				
1.214.100					
1.210.105	8m				
1.214.105		1.214.204	7m	1.214.275	7m
1.310.100	-				
1.314.100					
1.310.104	12m				
1.314.104		1.314.204	10m	1.314.275	10m
1.400.100	-				
1.404.100					
1.400.105	15m				
1.404.105		1.404.204	15m	1.404.273	15m
1.400.106	15m				
1.404.106					
3.400.100	-				
3.404.100					
3.400.105	15m				
3.404.105		3.404.204	15m	3.404.273	15m
3.400.106	15m				
3.404.106					
1.410.100	-				
1.414.100					
1.410.105	15m				
1.414.105		1.414.204	15m	1.414.273	15m
1.410.106	15m				
1.414.106					

Overview OSM / OSK 420 - 510

EBINGER

Technisches Equipment

Model	Material	Hose diameter Ø	Connection swivel joint*	Item-No.	Length	
				PVC-hose Cold water up to 10bar / 50°C		
OSM 420 Swivel wall bracket 	Painted steel	without hose	1/2" F	1.420.100	-	
	Painted steel	1/2" (12,5mm)		1.420.101	20m	
	Painted steel	5/8" (15,5mm)		1.420.102	15m	
OSM 500 Fixed mountig bracket 	Painted steel	without hose	1/2" F	1.500.100	-	
	Stainless steel			1.504.100		
	Painted steel	1/2" (12,5mm)		1.500.101	25m	
	Stainless steel			1.504.101		
	Painted steel	5/8" (15,5mm)		1.500.102	20m	
	Stainless steel			1.504.102		
OSK 500 Fixed mountig bracket 	Painted steel / ABS	without hose	1/2" F	3.500.100	-	
	Stainless steel / ABS			3.504.100		
	Painted steel / ABS	1/2" (12,5mm)		3.500.101	25m	
	Stainless steel / ABS			3.504.101		
	Painted steel / ABS	5/8" (15,5mm)		3.500.102	20m	
	Stainless steel / ABS			3.504.102		
	Painted steel / ABS	without hose		1" F	3.500.130	-
	Stainless steel / ABS				3.504.130	
	Painted steel / ABS	3/4" (19mm)			3.500.131	15m
	Stainless steel / ABS				3.504.131	
	Painted steel / ABS	1" (25mm)			3.500.132	8m
	Stainless steel / ABS				3.504.132	
OSM 510 Swivel wall bracket 	Painted steel	without hose	1/2" F		1.510.100	-
	Stainless steel				1.514.100	
	Painted steel	1/2" (12,5mm)			1.510.101	25m
	Stainless steel				1.514.101	
	Painted steel	5/8" (15,5mm)			1.510.102	20m
	Stainless steel				1.514.102	

*All hose reels incl. hose are equipped with an brass coupling

Overview OSM / OSK 420 - 510

EBINGER

Technisches Equipment

Item-No.	Length	Item-No.	Length	Item-No.	Length
rubber hose ET hot water up to 15bar / 90°C		Food hose, resistant to animal & vegetable fats up to 15bar / 100°C		TPE hose Drinking water KTW-A, TZW AZ: 5-0885/21, DIN EN 16421: 2015-05 up to 10bar / 60°C	
					
1.420.100	-				
1.420.105	15m				
1.420.106	12m				
1.500.100	-				
1.504.100	-				
1.500.104	20m				
1.504.104		1.504.204	20m	1.504.273	20m
1.500.105	15m				
1.504.105					
3.500.100	-				
3.504.100	-				
3.500.104	20m				
3.504.104		3.504.204	20m	3.504.273	20m
3.500.105	15m				
3.504.105					
3.500.130	-				
3.504.130	-				
3.500.135	15m				
3.504.135		3.504.237	15m	3.504.275	15m
3.500.136	8m				
3.504.136		3.504.238	8m	3.504.276	8m
1.500.100	-				
1.514.100	-				
1.510.104	20m				
1.514.104		1.514.204	20m	1.514.273	20m
1.510.105	20m				
1.514.105					

Overview OSM / OSK 610 - 710

EBINGER

Technisches Equipment

Model	Material	Hose diameter Ø	Connection swivel joint*	Item-No.	Length			
				PVC-hose Cold water up to 10bar / 50°C				
OSM 610 Fixed mountig bracket  	Painted steel	without hose	1/2" F	1.610.100	-			
	Stainless steel			1.614.100				
	Painted steel	1/2" (12,5mm)		1.610.101	30m			
	Stainless steel			1.614.101				
	Painted steel	5/8" (15,5mm)		1.610.102	25m			
	Stainless steel			1.614.102				
	Painted steel	without hose		1" F	1.610.130	-		
	Stainless steel				1.614.130			
	Painted steel	3/4" (19mm)			1.610.131	20m		
	Stainless steel				1.614.131			
	Painted steel	1" (25mm)			1.610.132	15m		
	Stainless steel				1.614.132			
	OSK 610 Fixed mountig bracket  	Painted steel/ ABS			without hose	1" F	3.610.150	-
		Stainless steel / ABS					3.614.150	
Painted steel / ABS		3/4" (19mm)	3.610.151		25m			
Stainless steel / ABS			3.614.151					
Painted steel / ABS		1" (25mm)	3.610.152		15m			
Stainless steel / ABS			3.614.152					
OSM 710 Fixed mountig bracket  	Painted steel	without hose	1/2" F		1.710.100	-		
	Stainless steel				1.714.100			
	Painted steel	1/2" (12,5mm)		1.710.101	60m			
	Stainless steel			1.714.101				
	Painted steel	5/8" (15,5mm)		1.710.102	50m			
	Stainless steel			1.714.102				
	Painted steel	without hose		1" F	1.710.130	-		
	Stainless steel				1.714.130			
	Painted steel	3/4" (19mm)			1.710.131	40m		
	Stainless steel				1.714.131			
	Painted steel	1" (25mm)			1.710.132	30m		
	Stainless steel				1.714.132			





*All hose reels incl. hose are equipped with an brass coupling

Overview OSM / OSK 610 - 710

EBINGER

Technisches Equipment

Item-No.	Length	Item-No.	Length	Item-No.	Length
rubber hose ET hot water up to 15bar / 90°C		Food hose, resistant to animal & vegetable fats up to 15bar / 100°C		TPE hose Drinking water KTW-A, TZW AZ: 5-0885/21, DIN EN 16421: 2015-05 up to 10bar / 60°C	
					
1.610.100	-				
1.614.100					
1.610.104	30m				
1.614.104				1.614.273	30m
1.610.105	25m				
1.614.105					
1.610.130	-				
1.614.130					
1.610.135	20m				
1.614.135		1.614.237	20m	1.614.275	20m
1.610.136	15m				
1.614.136		1.614.238	15m	1.614.276	15m
3.610.150	-				
3.614.150					
3.610.155	20m				
3.614.155		3.614.257	20m	3.614.275	20m
3.610.156	15m				
3.614.156				3.614.276	15m
1.710.100	-				
1.714.100					
1.710.104	40m				
1.714.104		1.714.204	40m		
1.710.105	40m				
1.714.105					
1.710.130	-				
1.714.130					
1.710.135	40m				
1.714.135		1.714.237	40m	1.714.275	40m
1.710.136	30m				
1.714.136		1.714.238	30m	1.714.276	30m

Model	Dimensions mm LxWxH & weight	Item-No.	Hose capacity	Features
SPG 100/P 	780 x 880 x 1100 20kg	2.880.060	80m - 1" 100m - 3/4"	<ul style="list-style-type: none"> ◦ galvanised frame ◦ painted drum ◦ pneumatic wheels ◦ swivel joint max. 8bar ◦ inlet 1"M ◦ outlet 3/4" M
SPG 50/P 	630 x 860 x 1040 12kg	2.880.050	50m - 1" 80m - 3/4"	<ul style="list-style-type: none"> ◦ galvanised frame ◦ painted drum ◦ pneumatic wheels ◦ swivel joint max. 8bar ◦ inlet 1"M ◦ outlet 3/4" M
PC 100/P 	525 x 660 x 1040 9kg	2.880.040	50m - 3/4" 80m - 1/2"	<ul style="list-style-type: none"> ◦ galvanised frame ◦ painted drum ◦ pneumatic wheels ◦ swivel joint max. 8bar ◦ inlet / outlet 3/4" M
HS 120/P 	445 x 620 x 820 7kg	2.880.030	60m - 1/2"	<ul style="list-style-type: none"> ◦ galvanised frame ◦ painted drum ◦ plastic wheels ◦ swivel joint max. 8bar ◦ inlet 1/2" M ◦ outlet 3/4" M

Hose sets for hose reels, with brass coupling at the end of the hose and swivel joint, fully integrated





Suitable for hose cart	length	Hose Ø	Item-No.
SPG 100/P	80m	1"	ASET00017
	100m	3/4"	ASET00018
SPG 50/P	50m	1"	ASET00015
	80m	3/4"	ASET00016
PC 100/P	50m	3/4"	ASET00013
	50m	5/8"	ASET00014
HS 120/P	50m	1/2"	ASET00012



Hose carts & manual hose reels

EBINGER

Technisches Equipment

Model	Dimensions mm LxWxH & weight	Item-No.	Hose capacity	Features														
EBS 100 	540 x 570 x 950 11kg	2.830.060	80m - 1/2" 60m - 5/8" 50m - 3/4"	<ul style="list-style-type: none"> ◦ stainless steel frame ◦ solid rubber wheels ◦ galvanized swivel joint, up to 8bar ◦ locking device ◦ connection 3/4"M 														
EBS 200 	590 x 760 x 1150 18kg	2.830.070	150m - 1/2" 120m - 3/4" 80m - 1"	<ul style="list-style-type: none"> ◦ stainless steel frame ◦ solid rubber wheels ◦ galvanized swivel joint, up to 8bar ◦ locking device ◦ connection 3/4"M 														
MC 200 	730 x 630 x 460 7kg	2.890.030	70m - 1/2" 45m - 3/4"	<ul style="list-style-type: none"> ◦ galvanized frame ◦ painted drum ◦ fixed mounting bracket ◦ swivel joint up to 8bar ◦ connection 15/19mm grommet 														
MGL 	24-70kg	2.940.010 MGL 200 2.940.040 MGL 500 2.940.050 MGL 600 2.940.060 MGL 700 2.940.070 MGL 800 2.940.080 MGL 900 2.940.095 MGL 1100	50m - 1" 100m - 1" 40m - 1 1/2" 30m - 2" 25m - 2" 20m - 1 1/2" 18m - 1 1/2"	<ul style="list-style-type: none"> ◦ painted steel casing ◦ sturdy steel frame ◦ axle with ball bearings ◦ drum locking device ◦ fixed mounting bracket <table border="1"> <thead> <tr> <th colspan="2">Optionales Zubehör</th> </tr> <tr> <th>Artikel-Nr.</th> <th>Bezeichnung</th> </tr> </thead> <tbody> <tr> <td>130.009</td> <td>Roller hose guide outlet with handle for MGL 500</td> </tr> <tr> <td>130.019</td> <td>Roller hose guide outlet for MGL 200</td> </tr> <tr> <td>130.028</td> <td>Roller hose guide outlet for MGL 600</td> </tr> <tr> <td>130.034</td> <td>Roller hose guide outlet for MGL 900</td> </tr> <tr> <td>130.010</td> <td>Hose cart SW 10</td> </tr> </tbody> </table>	Optionales Zubehör		Artikel-Nr.	Bezeichnung	130.009	Roller hose guide outlet with handle for MGL 500	130.019	Roller hose guide outlet for MGL 200	130.028	Roller hose guide outlet for MGL 600	130.034	Roller hose guide outlet for MGL 900	130.010	Hose cart SW 10
Optionales Zubehör																		
Artikel-Nr.	Bezeichnung																	
130.009	Roller hose guide outlet with handle for MGL 500																	
130.019	Roller hose guide outlet for MGL 200																	
130.028	Roller hose guide outlet for MGL 600																	
130.034	Roller hose guide outlet for MGL 900																	
130.010	Hose cart SW 10																	

Hose reel ASR

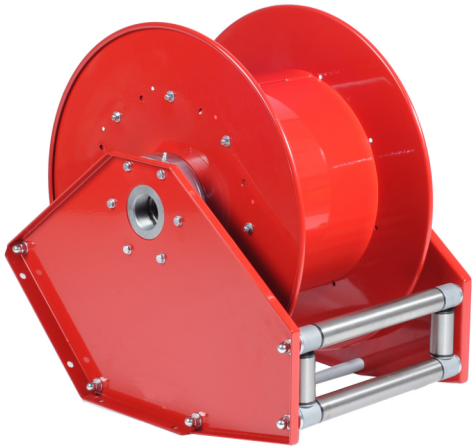

- Spring rewind mechanism
- Latching system
- Casing complete in painted steel*
- Alternatively with stainless steel media guide
- Fixed mounting bracket
- Tractive force up to 35 - 45kg
- pressure max. 20bar (also suitable for vacuum applications)
- Without hose and hose stopper

Model	Item-No.	Inlet / outlet	Axle	Hose capacity
ASR 50	2.600.050	2" IG Galv. steel	Painted steel	7m - 50mm 10m - 38mm
	2.602.050	2" IG Stainless steel	Stainless steel	
ASR 100	2.600.100	2" IG Galv. steel	Painted steel	10m - 50mm 15m - 38mm
	2.602.100	2" IG Stainless steel	Stainless steel	
ASR 200	2.600.200	2" IG Galv. steel	Painted steel	15m - 50mm 20m - 38mm
	2.602.200	2" IG Stainless steel	Stainless steel	
ASR 300	2.600.300	2" IG Galv. steel	Painted steel	20m - 50mm 25m - 38mm
	2.602.300	2" IG Stainless steel	Stainless steel	
ASR 400	2.600.400	2" IG Galv. steel	Painted steel	25m - 50mm 30m - 38mm
	2.602.400	2" IG Stainless steel	Stainless steel	

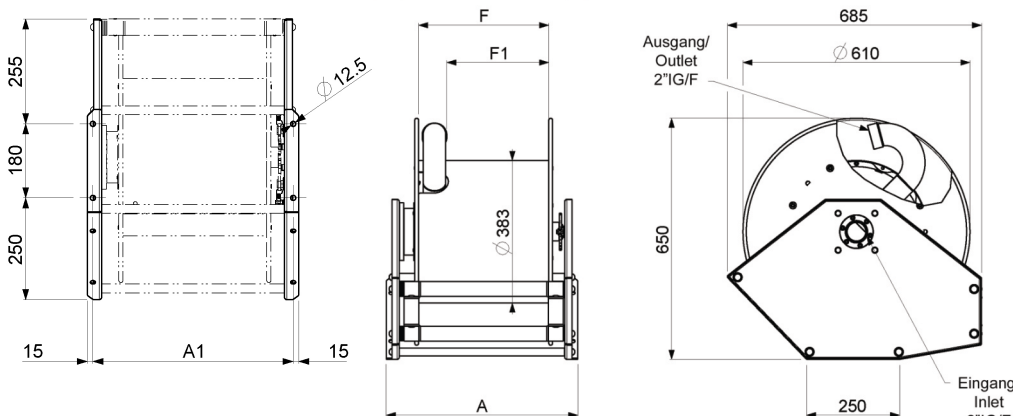

Model	A	A1	F	F1	kg
ASR 50	415	388	250	170	47
ASR 100	515	488	350	270	50
ASR 200	625	598	460	380	56
ASR 300	715	688	550	470	68
ASR 400	715	748	610	530	70

Optional accessories	
Item-No.	Designation
130.032	Hose stopper for hose 2"
130.033	Adapter for hose 1½"

*Casing in stainless steel available on request

Manual hose reel HM



- Security handle-system that allows the handle to stay in place, avoiding the rotation during the manual hose unreeling
- Sturdy drum
- Casing in painted steel or stainless steel
- Adjustable rewinding break
- Stable mounting bracket
- Pressure up to 20bar
- Drum supporting brushings made from TENAXID



Model	Casing	Item-No.	Swivel connection	Hose capacity
HM 610 	Painted steel	8.610.100	1/2" F	110m - 1/4"
	Stainless steel	8.614.100		60m - 3/8"
	Painted steel	8.610.130	1" F	45m - 1/2"
	Stainless steel	8.614.130		25m - 5/8"
HM 710 	Stahl lackiert	8.710.100	1/2" F	200m - 1/4"
	Edelstahl	8.714.100		120m - 3/8"
	Stahl lackiert	8.710.130	1" F	85m - 1/2"
	Edelstahl	8.714.130		60m - 5/8"
				45m - 3/4"
				30m - 1"

HM 610 - Dimensions in mm

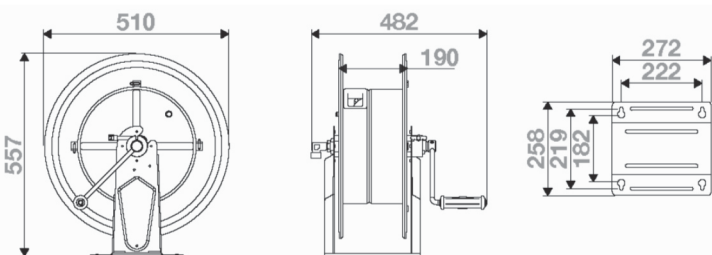

HM 710 - Dimensions in mm

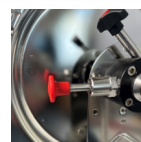
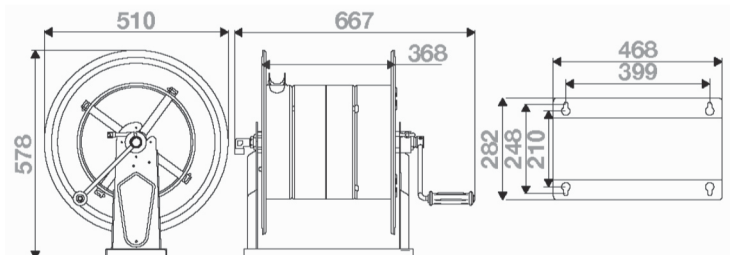





Optional accessories	
Item-No.	Designation
8.000.001	Locking pin





Optional accessories OSM & OSK



Item-No.	Material	OSM 210	OSM 400 OSK 400	OSM 410*	OSM 500 OSK 500	OSM 510*	OSM 610 OSK 610	OSM 710
Swiveling wall bracket* 	steel	1.110.001	1.110.001		1.510.001		1.610.007	1.710.001
	stainless steel	1.114.001	1.114.001		1.514.001		1.614.007	1.714.001
Cover plate for latching system** 	ABS		1.410.005	1.410.005	1.510.005	1.510.005	1.510.005	1.510.005
Extension for swiveling wall bracket 180° 	stainless steel			1.514.007		1.514.007		
Wall bracket 	steel						1.610.004	1.710.004
	stainless steel						1.614.004	1.714.004
Turntable, only suitable for floor mounting 	galv. steel				1.610.002		1.610.002	1.710.002
Automatic hose guide 1/2" - 5/8" hose 	steel		1.410.010	1.410.010	1.510.010	1.510.010	1.610.010	1.710.010
	stainless steel		1.414.010	1.414.010	1.514.010	1.514.010	1.614.010	1.714.010
Automatic hose guide 3/4" hose 	steel				1.510.011	1.510.011	1.610.011	1.710.011
	stainless steel				1.514.011	1.514.011	1.614.011	1.714.011
Automatic hose guide 1" hose 	steel						1.610.012	1.710.012
	stainless steel						1.614.012	1.714.012
Hose guide, 180° transshiptable 	-I				1.610.003		1.610.003	1.610.003
„speed control“ rewinding breat** 	Techno-Polymer		1.410.008	1.410.008	1.410.008	1.410.008	1.410.008	1.410.008
Hose trolley with 4 breaking solid rubber wheels 	steel				130.001		130.001	130.001
	stainless steel				130.003		130.003	130.003
Hose trolley with 4 breaking solid air wheels	steel				130.002		130.002	130.002
	stainless steel				130.004		130.004	130.004

*For models OSM 310, 410 and 510, the swivel wall bracket is included in the scope of delivery.

** Cover plate and return brake cannot be combined with automatic hose guide and hose guide transshiptable

Watering devices and guns		Item-No.
Watering device WATER PROFI With watering spray, 0,7mm, manual valve, brass coupling, 60cm, 0,66kg		130.360
Hand wash shower CLEANER PROFI With shower head, 1mm, manual valve, brass coupling, 25cm, 0,53kg		130.368
Pistolenspritze, Typ 460 Aus Kunststoff / Messing, stufenlos verstellbar, MS-Schnellkupplung, 0,33kg		130.140
Spraying gun, Typ 460 Made of plastic / brass, infinitely adjustable, brass coupling, 0,33kg		130.141
Professional cleaning gun Brass grubber-coated, up to max. 25bar, 80°C, 24l/min at 5bar, with brass coupling, 1/2" F, 0,75kg		130.142

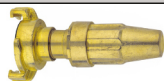
Brass couplings	M	F	Grommet	F 360° axial rotatable	Grommet detectable
					
1/2"	130.180	130.186	130.173	130.159	130.191
5/8"			130.174		
3/4"	130.181	130.187	130.175		130.192
1"	130.182	130.188	130.176		130.193
1 1/4"	130.183	130.189	130.177		130.194
1 1/2"	130.184	130.190	130.178		

Brass steel tubes, heavy	Brass couplings	Grommet
		
1/2"	130.168	130.165
3/4"		130.166
1"	130.170	130.167

Aluminium steel tubes, heavy	Storz D brass coupling	Storz C- Storz C
	130.115	130.116

Roller window for wall outlet	
Bore hole 7mm Distance 150mm, Inner dimensions 34x65mm	130.286
	

PVC water hose, up to 50°C



Inner Ø	Length	Max. pressure	Item-No.
1/2"	20m	12bar	130.801
	25m		130.802
	30m		130.803
	50m		130.804
	100m		130.805
5/8"	25m	10bar	130.806
	50m		130.807
	100m		130.814
3/4"	20m	10bar	130.768
	40m		130.769
	50m		130.799
	100m		130.800
1"	15m	10bar	130.770
	30m		130.771
	50m		130.798
	100m		130.833
1 1/4"	25m	10bar	130.821
	50m		130.704

Rubber water hose "Eurotrix", up to 100°C



Inner Ø	Length	Max. pressure	Item-No.
1/2"	20m	15bar	130.829
3/4"			130.827
1/2"	40m		130.724
5/8"			130.778
3/4"			130.725
1"			130.726

PVC spiral hose, up to 50°C, with steel spiral, suitable for vacuum



Inner Ø	Length	Max. pressure	Item-No.
1/2"	30m	8bar	130.780
3/4"			130.781
1"			130.782
1 1/4"		6bar	130.783
1 1/2"			130.784
1 1/2"			130.739
2"	5bar	130.785	

Rubber water hose "Trix-Rotstrahl", up to 120°C



Inner Ø	Length	Max. pressure	Item-No.
1/2"	50m	20bar	130.707
5/8"	40m		130.708
3/4"			130.709
1"			130.710

Rubber water hose "Aqualife" TPE, up to 70°C, according to KTW-A, TZW AZ: 5-0885/21, DIN EN 16421: 2015-05

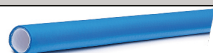

Inner Ø	Length	Max. pressure	Item-No.
1/2"	50m	15bar	130.791
3/4"			130.792
1"		10bar	130.855

Rubber water hose "Thermoclean", up to 100°C / steam 164°C (max. 6bar), Externally resistant to animal fats



Inner Ø	Length	Max. pressure	Item-No.
1/2"	20m	15bar	130.729
3/4"			130.730
1"			130.731
1/2"	40m		130.844
3/4"			130.846
1"			130.847

Further versions available on request

